

ceiling trims

... for versatile designer ceilings

Ceilings are increasingly being used as a design feature that draws the eye and creates an impression to enhance the living and working space.

Design features such as Bulkheads, changes of ceiling level and plasterboard perimeters considerably enhance the aesthetic interest of an interior, the interface of building materials however is a critical factor in the appearance of the overall interior finish.

Our Ceiling Trim range is designed to assist architects, designers and ceiling specialists with solutions to achieve the desired seamless finish that is required in a decorative feature ceiling.

The Ceiling Trim range includes a number of profiles which have been specifically developed to provide the opportunity to create interesting features with crisp clean interface details for suspended and plasterboard ceiling installations.

Features and Benefits:

- The precise alignment between sections
- No risk of cracks or uneven gaps at the junction of the wall and ceiling
- Perfectly true lines
- Powder coated white finish as standard
- Pre-drilled profiles improving efficiency and costs on site

Profile Name	Dimensions (mm)	Length (mm)	Shadow off the Wall (mm)	Ceiling Drop (mm)	Ceiling Application
PS1	20 x 20	4000	20	20	Suspended
PS2	25 x 20	4000	25	20	Flush Plastered
PS3	45 x 20	4000	45	20	Flush Plastered
PS4	45 x 45	4000	45	45	Flush Plastered

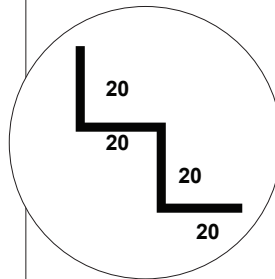
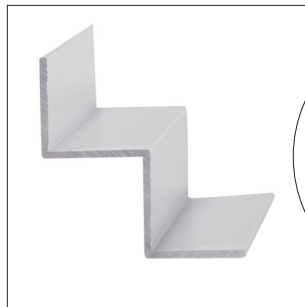

PS1 Shadowline Wall Trim:

An aluminium profile designed to create a 20 x 20mm Shadowline between an exposed suspended ceiling and the perimeter wall.

PS2, 3 & 4 Shadowline Trim Profiles:

Aluminium profiles designed to create a Shadowline between a concealed ceiling and the perimeter wall using JUMBO Plasterboard.

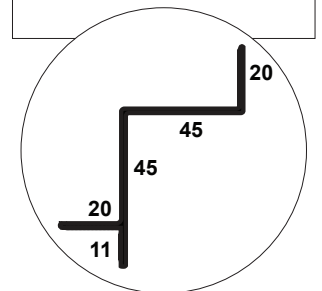
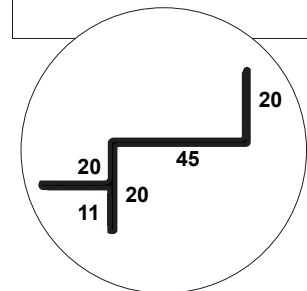
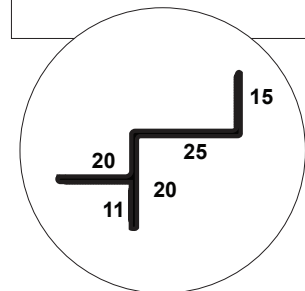
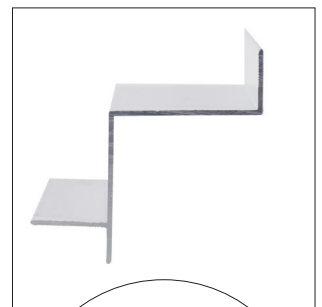
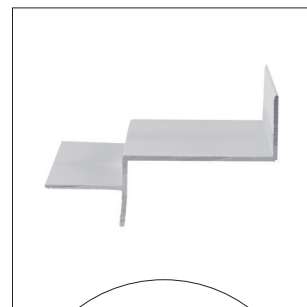
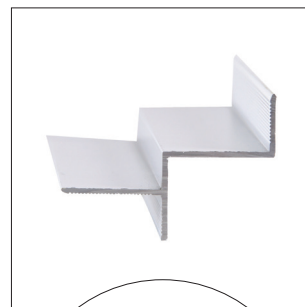

Shadowline Profiles add a great sensation of height and space, the clean geometric lines and recessed shadows accentuate a feeling of spacious upmarket style.

PS5 and PS6 Steel Shadowline Plaster Trim

A steel profile designed to create a Shadowline between a concealed ceiling and the perimeter wall using JUMBO Plasterboard.



ceiling systems

partitioning systems

opening systems

flooring systems



Head Office / Durban
(031) 563 7307
Pietmaritzburg Branch
(033) 345 3701

For export and all other regions
contact our head office or
one of our distributors.

Distributors:

Zululand

Above All Ceiling & Partitioning Systems
(035) 751 1956

Northern KZN

SAIBA Industries (Pty)
(034) 375 6051/2

South Coast

Southgate Ceilings & Partitions
(039) 314 9021

East London & Border Area

Almex East London
(043) 736 6334

Port Elizabeth

Amalgamated
(041) 451 2846

Krugersdorp

Ceiling Dynamix
(011) 660 6584

Northriding, Johannesburg

C+T Ceilings & Partitions Warehouse
(011) 704 6224

Centurion, Pretoria

C+T Ceilings & Partitions warehouse
(012) 653 3531

Alrode, Johannesburg

Supertec Ceilings & Board
(011) 868 4901

Troyeville, Johannesburg

Supertec Ceilings & Board
(087) 943 4040

Wynberg, Johannesburg

Supertec Ceilings & Board
(011) 440 3712

Hamilton, Bloemfontein

Smart Boards (Pty) Ltd
(051) 430 8123

Visit our website on www.pelican.co.za
Email info@pelican.co.za



creating environments

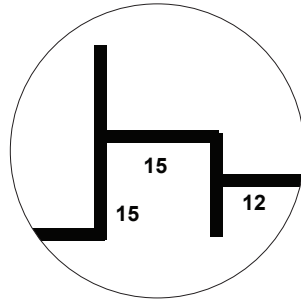
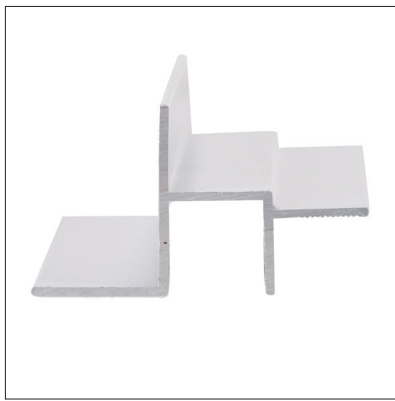

Plaster Ceiling Junction:

An aluminium profile designed to facilitate the transition between an exposed suspended ceiling and a flush plastered ceiling both on the same level with a reveal being created between the two types.

The Plaster Ceiling Junction can provide an attractive feature to a suspended ceiling and minimises the need for cut tiles.

This solution is particularly effective for irregular perimeters, corridors and small cellular spaces with existing structural walls.

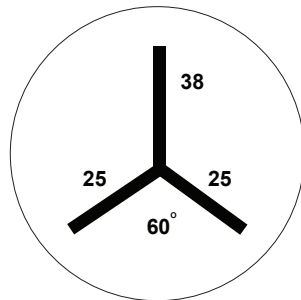
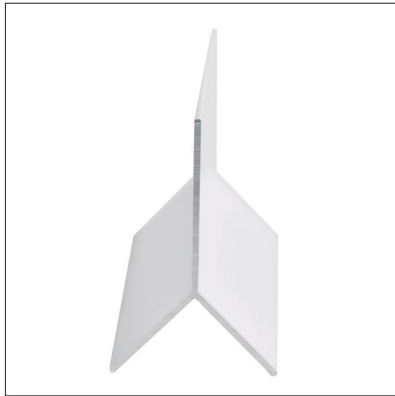

Apex Trim:

An aluminium profile designed to facilitate the junction between two raked ceilings.

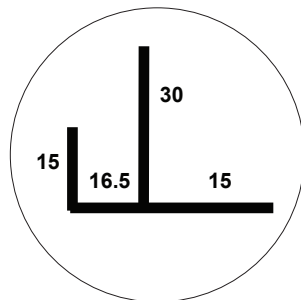
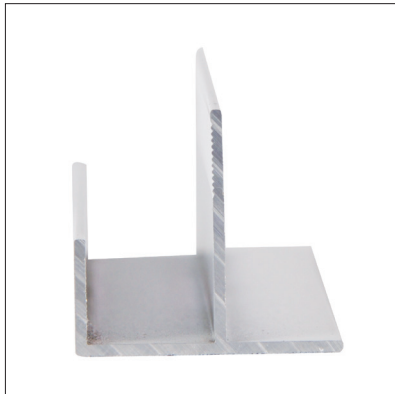

Facia Trim:

An aluminium profile designed to facilitate a vertical bulkhead at the edge of a suspended ceiling, especially against windows.

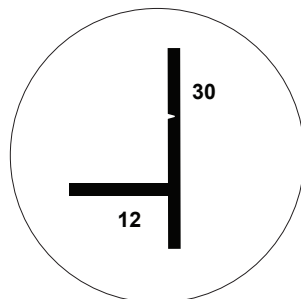

Plaster Curve Trim:

An aluminium profile designed to facilitate a radius wall with a flush plastered ceiling. Used with 16mm radiused Supawood to create a Shadowline on the perimeter.

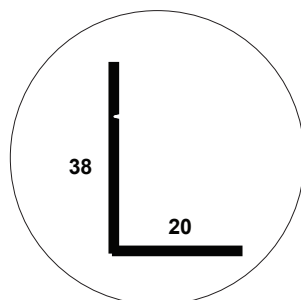

Shadow Curve Trim:

An aluminium profile designed to facilitate a radius wall with an exposed suspended ceiling. Used with 16mm radiused Supawood to create a Shadowline on the perimeter.