

# installation guide

## Kronotex Laminate Flooring - Installation of Profile Mouldings

After installing a Kronotex floor, you can walk on it and move all the furniture back in. Remove spacers and cover any expansion spaces. Your Kronotex dealer can supply you with matching and colour-coordinated trim. Install mouldings with pegs or screws. When doing this, make certain that you do not inadvertently fasten down the flooring planks with the trim. This would prevent the floating laminate surface from moving freely.

### 1) Skirting Profile

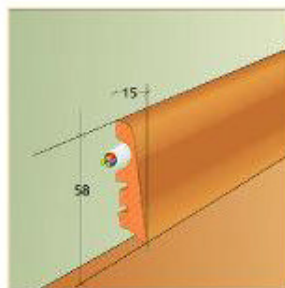

Skirting Boards - Ktex1

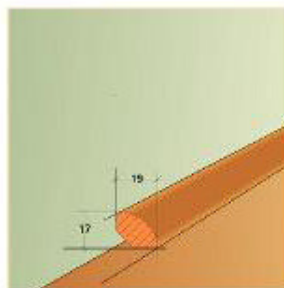

Skirting Boards - Ktex2

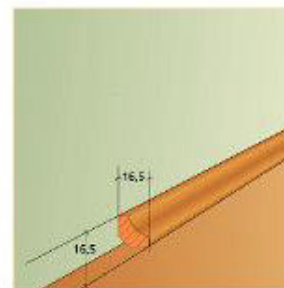

Skirting Boards - Ktex3

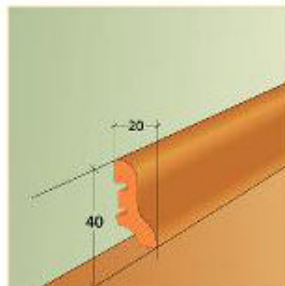

Skirting Boards - Ktex4

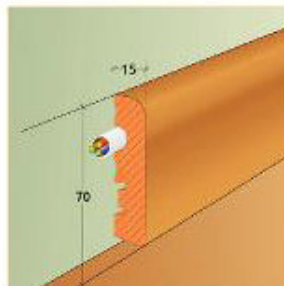

Skirting Boards - Ktex5

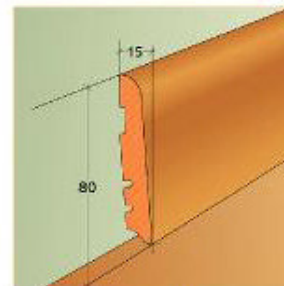

Skirting Boards - Ktex6

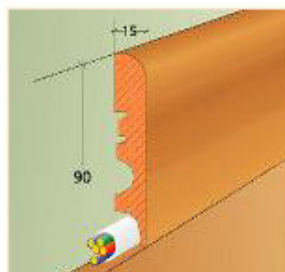

DIN EN 9001:2000  
CERTIFICATE NO. 01 100 8280061  
ISO CERTIFICATION FOR DURBAN ONLY

Tel: +27(0)31 563 7307  
Website: [www.pelican.co.za](http://www.pelican.co.za)  
Email: [info@pelican.co.za](mailto:info@pelican.co.za)



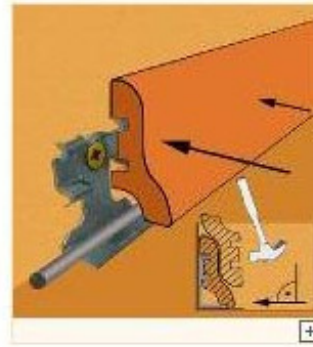
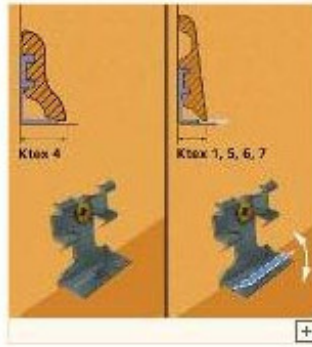

### Installation / Inner Corners

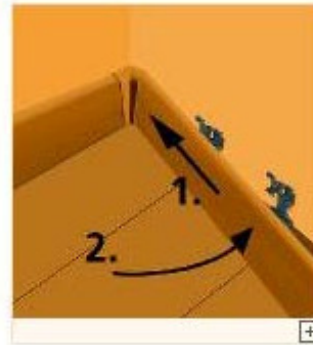
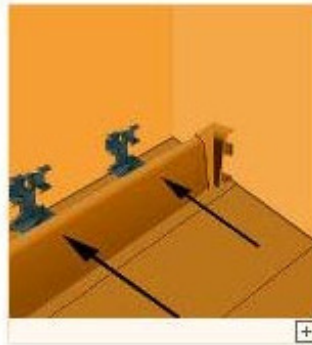
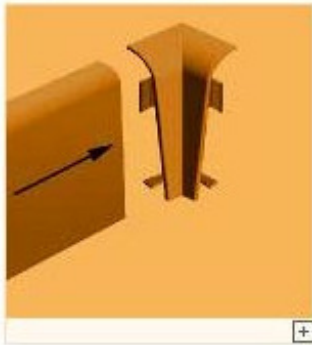

### Installation / Outer Corners

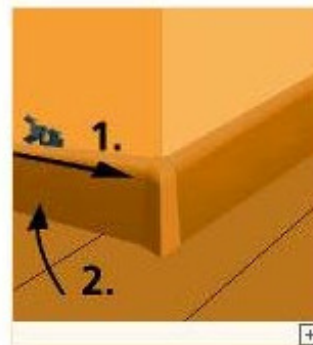
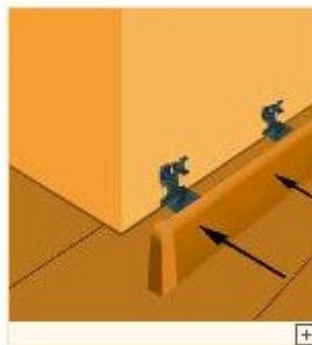
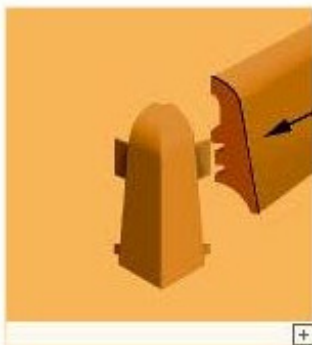

## 2) Border Profile



= 7 - 11 mm

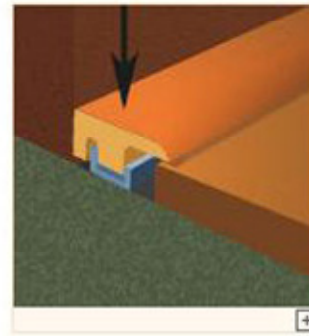
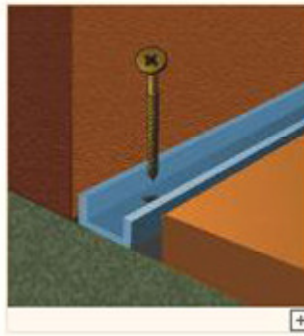
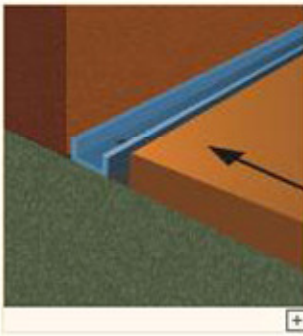

## 3) Transition Profile



= 7 - 11 mm

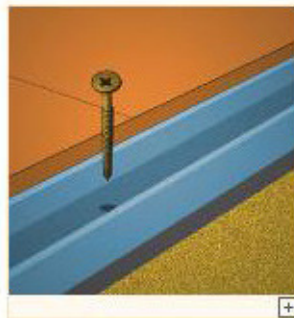
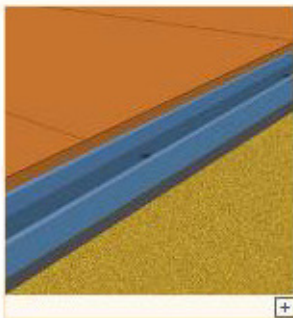

#### 4) Motion Profile

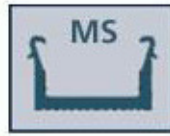

= 7 - 11 mm

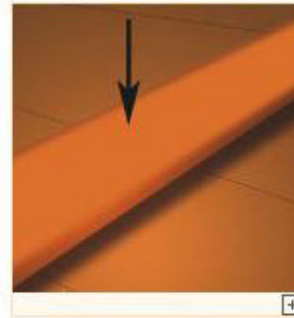
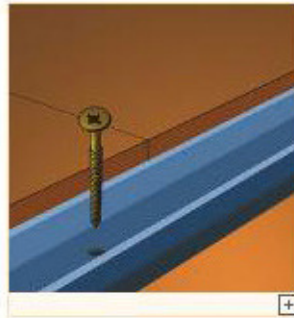
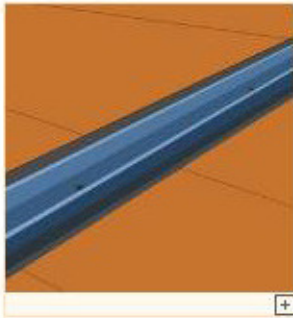

#### 5) Stair Profile



= 7 - 11 mm

